

PHILIPS

Strand Lighting

e521 LED Raceway



71900

Strand Lighting Offices

Strand Lighting - Dallas

10911 Petal Street
Dallas, TX 75238
Tel: 214-647-7880
Fax: 214-647-8031

Strand Selecon - Auckland

19-21 Kawana Street
Northcote, Auckland 0627
New Zealand
Tel: +64 9 481 0100
Fax: +64 9 481 0101

Strand Lighting - New York

267 5th Ave, 4th Floor
New York, NY 10016
Tel: 212-213-8219
Fax: 212-532-2593

Strand Lighting - Europe

Marssteden 152
Enschede 7547 TD
The Netherlands
Tel: +31 53 4500424
Fax: +31 53 4500425

Strand Lighting - Asia Limited

Room 6-10, 20/F Delta House 3 On Yiu Street
Shatin, N.T. Hong Kong
Tel: + 852 2757 3033
Fax: + 852 2757 1767

Website:

www.strandlighting.com

The material in this manual is for information purposes only and is subject to change without notice. Strand Lighting assumes no responsibility for any errors or omissions which may appear in this manual. For comments and suggestions regarding corrections and/or updates to this manual, please visit the Strand Lighting web site at www.strandlighting.com or contact your nearest Strand Lighting office.

El contenido de este manual es solamente para información y está sujeto a cambios sin previo aviso. Strand Lighting no asume responsabilidad por errores o omisiones que puedan aparecer. Cualquier comentario, sugerencia o corrección con respecto a este manual, favor de dirijirlo a la oficina de Strand Lighting más cercana.

Der Inhalt dieses Handbuches ist nur für Informationszwecke gedacht, Aenderungen sind vorbehalten. Strand Lighting uebernimmt keine Verantwortung für Fehler oder Irrtuemer, die in diesem Handbuch auftreten. Für Bemerkungen und Verbesserungsvorschlaege oder Vorschlaege in Bezug auf Korrekturen und/oder Aktualisierungen in diesem Handbuch, moechten wir Sie bitten, Kontakt mit der naechsten Strand Lighting-Niederlassung aufzunehmen.

Le matériel décrit dans ce manuel est pour information seulement et est sujet à changements sans préavis. La compagnie Strand Lighting n'assume aucune responsabilité sur toute erreur ou omission inscrite dans ce manuel. Pour tous commentaires ou suggestions concernant des corrections et/ou les mises à jour de ce manuel, veuillez s'il vous plait contacter le bureau de Strand Lighting le plus proche.

Information contained in this document may not be duplicated in full or in part by any person without prior written approval of Strand Lighting. Its sole purpose is to provide the user with conceptual information on the equipment mentioned. The use of this document for all other purposes is specifically prohibited.

2 Year Limited Warranty

Strand Lighting offers a two-year limited warranty of its products against defects in materials or workmanship from the date of delivery. A copy of Strand Lighting two-year limited warranty containing specific terms and conditions can be obtained from the Strand Lighting web site at www.strandlighting.com or by contacting your local Strand Lighting office.

Document Number: **2-450227-010 0**

Version as of: **19 July 2011**

eS21 LED Raceway Installation & Operation Guide

©2011 Philips Group. All rights reserved.

IMPORTANT INFORMATION

Warnings and Notices

When using electrical equipment, basic safety precautions should always be followed including the following:



- a. **READ AND FOLLOW ALL SAFETY INSTRUCTIONS.**
- b. Do not use outdoors.
- c. Do not mount near gas or electric heaters.
- d. Equipment should be mounted in locations and at heights where it will not readily be subjected to tampering by unauthorized personnel.
- e. The use of accessory equipment not recommended by the manufacturer may cause an unsafe condition.
- f. Do not use this equipment for other than intended use.
- g. Refer service to qualified personnel.

SAVE THESE INSTRUCTIONS.



WARNING: You must have access to a main circuit breaker or other power disconnect device before installing any wiring. Be sure that power is disconnected by removing fuses or turning the main circuit breaker off before installation. Installing the device with power on may expose you to dangerous voltages and damage the device. A qualified electrician must perform this installation.

WARNING: Refer to National Electrical Code® and local codes for cable specifications. Failure to use proper cable can result in damage to equipment or danger to personnel.

WARNING: This equipment is intended for installation in accordance with the National Electric Code® and local regulations. It is also intended for installation in indoor applications only. Before any electrical work is performed, disconnect power at the circuit breaker or remove the fuse to avoid shock or damage to the control. It is recommended that a qualified electrician perform this installation.

CAUTION: Wire openings **MUST** have fittings or lining to protect wires/cables from damage. Use 75° C copper wire only! Aluminum wire may not be used.

Additional Resources for DMX512

For more information on installing DMX512 control systems, the following publication is available for purchase from the United States Institute for Theatre Technology (USITT), "Recommended Practice for DMX512: A Guide for Users and Installers, 2nd edition" (ISBN: 9780955703522). USITT Contact Information:

USITT
315 South Crouse Avenue, Suite 200
Syracuse, NY 13210-1844
1-800-938-7488 or 1-315-463-6463
www.usitt.org

TABLE OF CONTENTS

Strand Lighting Offices	Inside Front Cover
2 Year Limited Warranty.....	Inside Front Cover
IMPORTANT INFORMATION	
Warnings and Notices.....	1
Additional Resources for DMX512.....	1
TABLE OF CONTENTS	
PREFACE	
About this Guide.....	3
Product Descriptions.....	3
eS21 LED RACEWAY SYSTEM OVERVIEW	
eS21 LED Raceway Components and Controls (230V/240V Models).....	4
LED Raceway Components	4
Head-End Processor	4
LED Quad Power Supply Modules	5
Dual Relay Modules	5
IGBT Dual 230V/240V, 2.5kW Dimmers	5
Power Requirements.....	5
Connecting Power.....	5
Connecting to the DMX512 Network.....	6
Connecting DMX512	6
Terminating DMX512	6
LED Raceway Mounting	7
DIMMER SYSTEM FUNDAMENTALS	
eS21 IGBT Dimmers	8
eS21 LED Raceway Modules.....	8
Dimmer Modules.....	8
LED Modules	10
OPERATION AND PROGRAMMING	
LCD Menu Operation	12
Splash Screens	13
Splash Screen Symbols.....	13
Philips Splash Screen 1	13
eS21 LED Strip DMX Splash Screen 2.....	14
User ID Splash Screen 3.....	14
Port DMX Splash Screen 4.....	15
LCD Menu System	15
LCD Menu Structure	15
LCD Display Passwords and Security.....	21
IGBT Dimmer Load Types.....	21
Dimmer Protection.....	22
Replacing a Module.....	23
TECHNICAL SPECIFICATIONS	
eS21 LED Raceway (230V/240V Model 71900).....	25
ACCESSORIES	
eS21 LED Raceway (230V/240V Model 71900).....	26
Clamps / Mounting / Hangers / DMX512 Termination	26
Spare Modules	26

PREFACE

1. About this Guide

The document provides installation and operation instructions for the following products:

- eS21 LED Raceway (230V) - Model 71900

Please read all instructions before installing or using this product. *Retain this guide for future reference.* Additional product information may be downloaded at www.strandlighting.com

2. Product Descriptions

eS21 LED Raceway (230V Model)



Note: Fixtures and accessories are sold separately and shown for illustrative purposes only.

Part Number	Description
71900	3-module raceway built to customer's order. Unit can include a mixture of any type of dimmer, LED, and/or relay control modules. See specification sheet for module options and ordering details.

Note: eS21 LED Raceways do not include input power cables.

ES21 LED RACEWAY SYSTEM OVERVIEW

1. eS21 LED Raceway Components and Controls (230V/240V Models)

LED Raceway Components

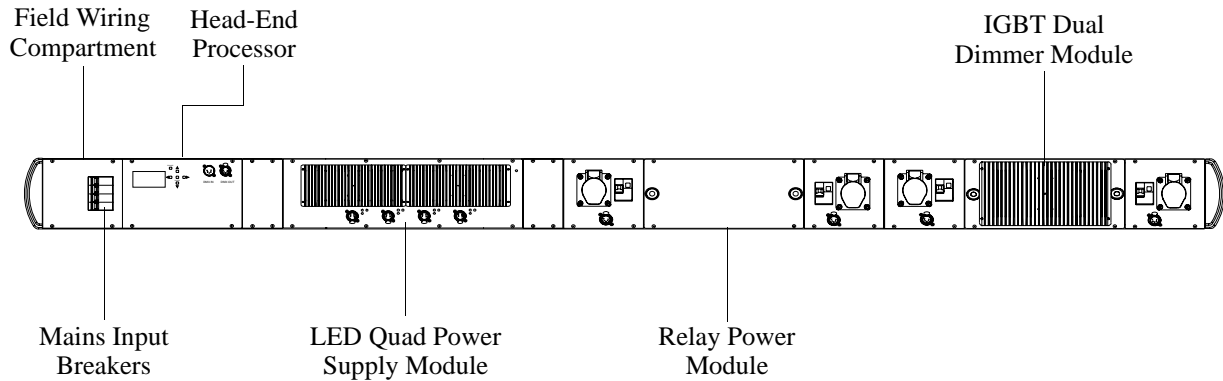

Notes:

1. Modules are per customer order. Modules shown are for illustrative purposes only.
2. Power Input Strain Relief (not shown) can be in one of three positions - top, bottom, or rear of unit at Field Wiring Compartment.

Head-End Processor

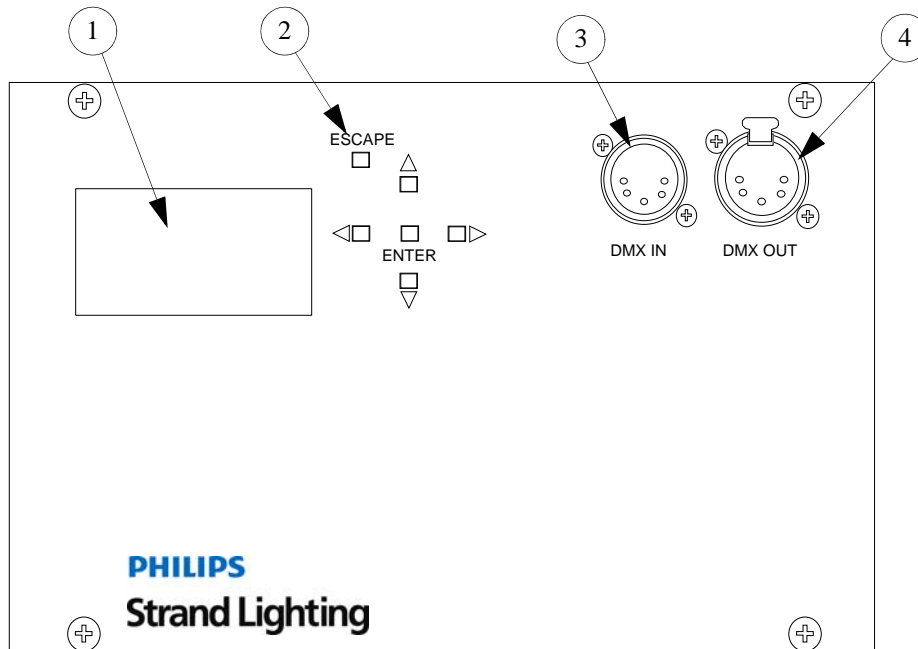

- 1) LCD Display (Menu System)
- 2) Function (Menu System) Select Push Buttons
- 3) DMX512 Input Connector
- 4) DMX512 Pass-Through Connector

LED Quad Power Supply Modules

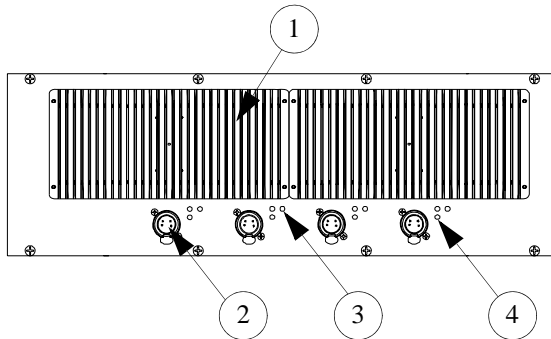

- 1) Control Module Heatsink (2 each)
- 2) Device Receptacle (4 each - 4-Pin XLR for Data and Device Power)
- 3) Focus Button (4 each - one for each control circuit)
- 4) Status LEDs (4 sets - one red and one green for each control circuit)

Dual Relay Modules

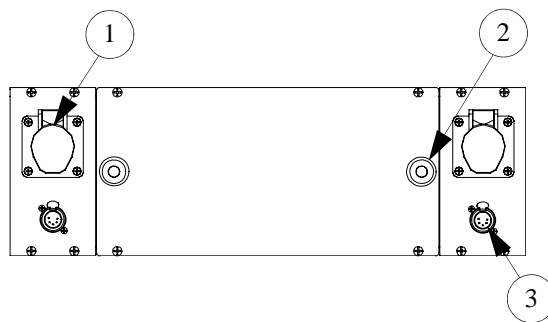

- 1) Load Receptacle (2 each - one for each relay circuit - CEE17 option shown)
- 2) Illuminated Focus Button (2 each - one for each relay circuit)
- 3) DMX Output Connection (2 each - one for each connected device)

IGBT Dual 230V/240V, 2.5kW Dimmers

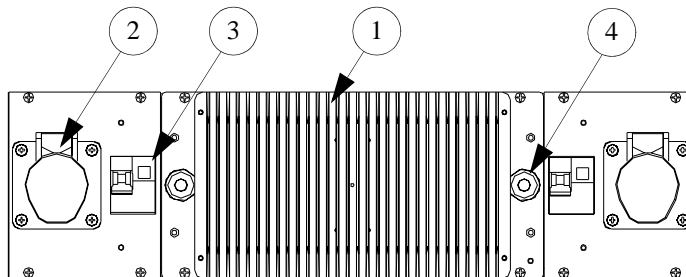

- 1) Dimmer Heatsink
- 2) Load Receptacle (CEE17 option shown)
- 3) Load Breaker (available with CEE17 receptacle option only)
- 4) Illuminated Focus Button (2 each - one for each dimmer)

2. Power Requirements

eS21 LED Raceways are designed to operate on a 50 or 60 Hertz, 25 Amp, 230 / 240 VAC, three phase "WYE" power service. These systems, however, will tolerate a wide variety of input voltages. For them to function normally the Phase to Neutral voltage must be in the range of 200 to 260 VAC.

If a system is mis-wired to voltages greater than 240 VAC, the dimmers will shut down and flash the 'Over Voltage' warning in the dimmer status field (See [“Dimmer Modules - LED Indicators”](#) on page 9). Dimmers will not attempt to bring up loads when in over-voltage shutdown.

3. Connecting Power

Field wiring of the eS21 LED Raceway is straight forward. A total of 5 wires need to be brought to the unit: The three "phase" wires (L1, L2, L3), a Neutral, and an Earth/Ground. The "phase" wires carry up to 25 amps each, and the Neutral carries the "unbalanced" current. The wires feeding all dimmers and dimmer outlets are wired in the same order.

The following scheme is suggested:

Connector	Wire	Conductor
"X" or "A"	Brown	L1
"Y" or "B"	Black	L2
"Z" or "C"	Gray	L3
"W" or "N"	Blue	Neutral
"G"	Green/Yellow	Earth (Ground)

4. Connecting to the DMX512 Network

Connecting DMX512

Basic DMX512 installation consists of Connecting eS21 LED Raceways together in "daisy-chain" fashion. A cable runs from the control console to the "DMX IN" connector on the first eS21 LED Raceway . Another cable runs from the "DMX OUT" connector on the first unit to the "DMX IN" connector on the second LED Raceway. All units are connected together in this fashion. Do not exceed DMX512 cable length, number of maximum receivers, or termination rules.

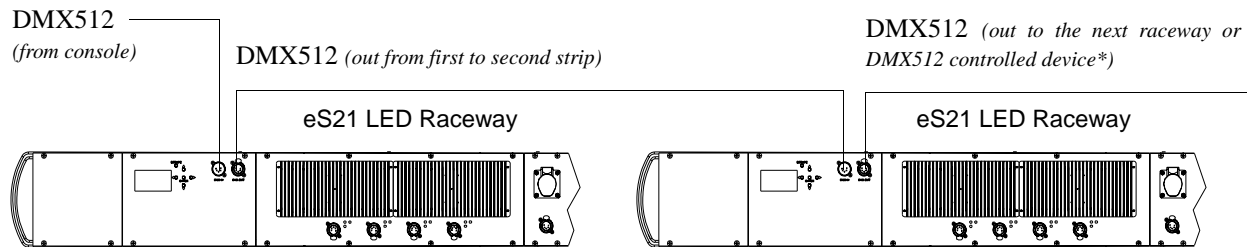

DMX512 Connections	
DMX512 Signal	XLR Pin Number
Common (Drain)	1
DMX512 -	2
DMX512 +	3
No Connection	4
No Connection	5

Note: * If there are no other DMX512 devices connected to the LED Raceway, then the LED Raceway must be terminated (see "[Terminating DMX512](#)").

Terminating DMX512

If a unit has cable plugged into its "DMX OUT" connector which runs to another eS21 LED Raceway or other DMX512 device, a DMX512 terminator is not required on the LED Raceway.

If a unit does not have a cable plugged into its "DMX OUT" connector, the LED Raceway must be terminated by a five-pin DMX512 termination plug (Strand Lighting part number 71346 or equivalent).

DMX512 Termination Plug

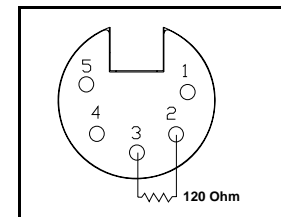
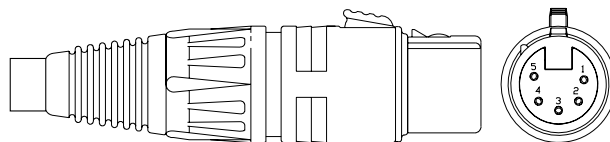

Note: For more information on DMX512 networking and systems, refer to "[Additional Resources for DMX512](#)" on page 1.

5. LED Raceway Mounting

There are several ways to mount eS21 LED Raceways. Below are the mounting brackets available from your Authorized Strand Lighting Dealer. Refer to "[ACCESSORIES](#)" on [page 26](#) for ordering information. Refer to each bracket's installation instructions for specific installation information. At least two of each bracket type are required for installation / mounting. All brackets and clamps are sold separately.

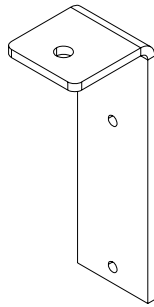

71726 - Pipe Mount Bracket*

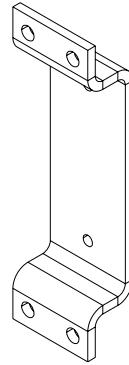
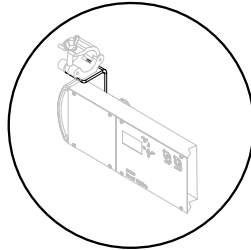

71728 - Wall Mount Bracket

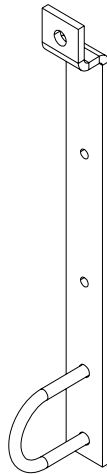
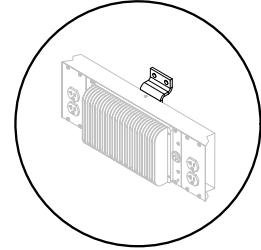

71732 - Single Pipe Mount Hanging Bracket

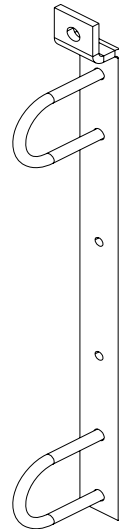
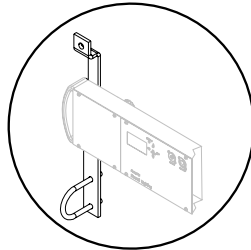

71733 - Double Pipe Mount Hanging Bracket

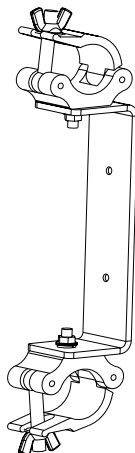
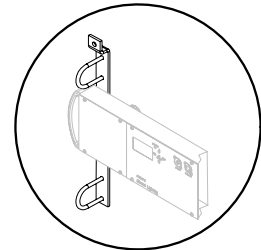

71511 - Dual Clamp Mount Hanging Bracket**

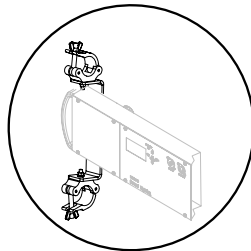

NOTES:

*For use with cheeseboro, pipe or hook clamps (clamps are sold separately for this bracket).

**Dual Clamp Mount Hanging Bracket (71511) includes two clamps.

DIMMER SYSTEM FUNDAMENTALS

1. eS21 IGBT Dimmers

The eS21 dimmers are multi-mode units that automatically analyzes its connected load and picks the most appropriate dimming technique. Depending on the load, the dimmer will use either Reverse Phase Control (RPC) or Forward Phase Control (FPC). Whenever possible, the dimmer will choose RPC because of the advantages it offers in terms of reduced lamp noise and increased regulation accuracy. Both techniques control the average power applied to the load by limiting current flow to only certain portions of each power line half cycle.

Forward Phase Control

Forward Phase Control is the technique used by all previous electronic dimmers, although earlier implementations have been far less sophisticated than eS21 dimmers. This scheme only allows current to flow during the latter portion of each half cycle. As the relative duration of the conducting portion is increased, so is the average power applied to the load, and hence its brightness.

Reverse Phase Control

Reverse Phase Control, on the other hand, limits current flow to the early portions of each half cycle. The dimmer monitors the power applied to the load in real time during the half cycle and adjusts its switch-off point as needed to regulate the light output.

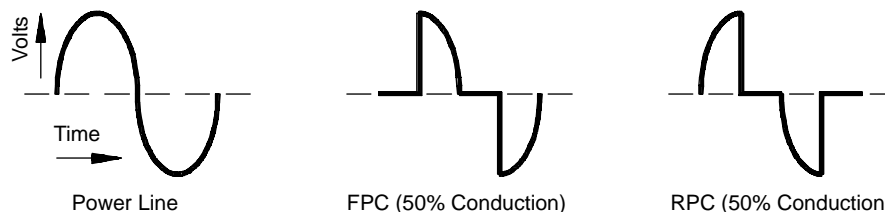

When switching-off the output in each half cycle, it is important to control the slope of the falling wave form so as to minimize the acoustic noise made by the lamp filament, and the radio frequency noise radiated by the dimmer. Previous dimming technologies accomplished this by placing a large coil of wire in series with the output of the dimmer. The unique power stage in eS21 dimmers allows this function to be performed directly in the dimmer. By stretching this fall time out to 400 or even 650 μ S, eS21 dimmers achieve exceptionally quiet operation without high insertion losses, and without the line distortion caused by inductors.

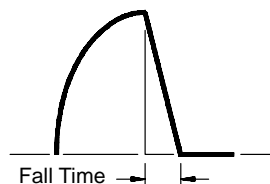

Note: Some manufacturers sometimes refer to "Forward Phase Control" as "Leading Edge" and "Reverse Phase Control" as "Trailing Edge."

2. eS21 LED Raceway Modules

Dimmer Modules

Each eS21 LED Raceway Dimmer Module contains a dual dimmer assembly (2.5kW) with power shared between the two dimmers within the module. Each dual dimmer module includes two Focus/LED Indicator buttons (see **Figure 1**), that functions as both focus adjustment control and status indicator for its dimmer.

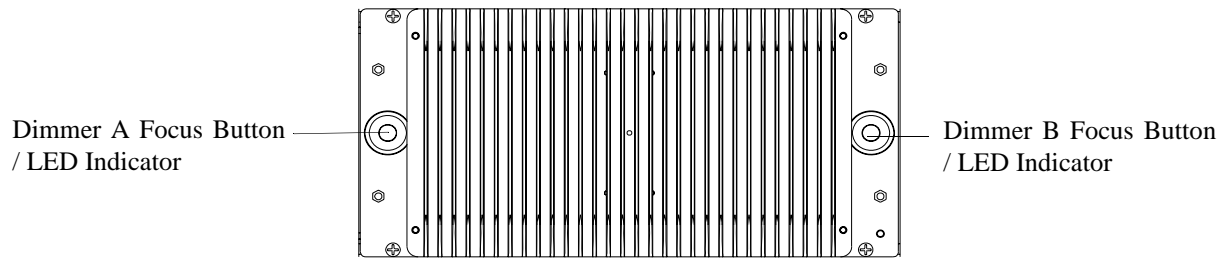

Figure 1: Dimmer Module Focus Buttons / LED Indicators

Dimmer Module - Focus Buttons

The Focus Buttons can be used to quickly set the output level to test the output of the module as follows:

- If the module is Off, a tap on the button will take it to full on.
- If the module is On, a tap will turn it off.
- Whether On or Off, pressing and holding the button will ramp up the intensity level. Releasing the button will hold the setting at an intermediate level.

Note: Fixtures turned on by the Focus Button will remain on until a control console sets a non-zero DMX512 level for the module. The module's level setting will be cancelled and it will now follow console control. If the module is already set to a non-zero DMX512 level by the console, the button becomes a "Flash-to-Full" control, overriding the level only while the button is pressed.

Dimmer Modules - LED Indicators

The two LEDs associated with each dimmer report various operating conditions. The Red LED turns on for approximately 4 seconds on power-up, and after that the indications are as follows:

Red LED	Green LED	Condition
Off	Off	Normal
Off	Flashing	No Load
Off	On	Focus Mode (controlled at dimmer)
Flashing (1.5 sec On, 0.5 sec Off)	Off	Oversized Load or Overload
Flashing (0.5 sec On, 0.5 sec Off)	Off	Over Operational Temperature
On	Off	No Communications with Head-End Processor
Flashing	Flashing	Over Voltage

LED Modules

Each eS21 LED Raceway LED Module contains four channels of LED luminaire control. The module is a LED power supply that is designed to deliver power and data (through its four low-voltage connectors) to power and control any Selecon PL Wash luminaire or Color Kinetics Blast fixtures. See **Figure 2** for details.

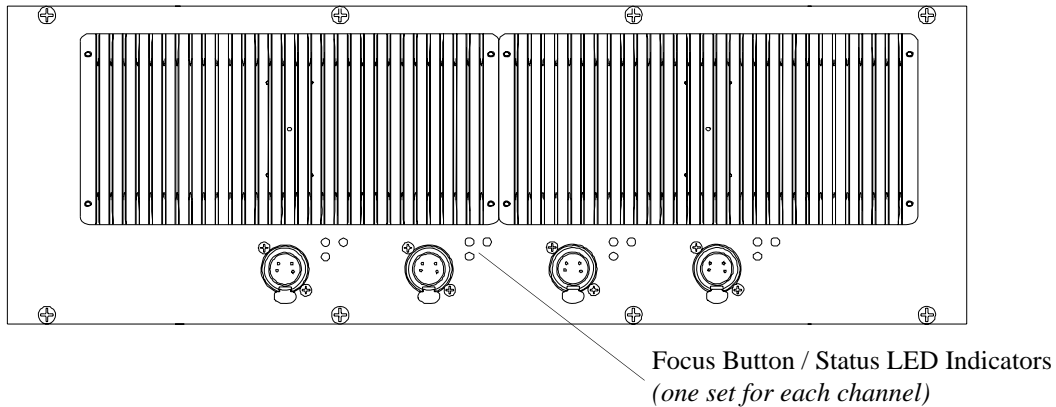

Figure 2: LED Module Focus Buttons / LED Indicators

LED Module - Focus Buttons

The Focus Buttons can be used to quickly operate or test the fixtures as follows:

- Tap - toggles fixtures from OFF to ON (or ON to OFF) on all channels if DMX512 signal is not present.
- Hold - turns fixture ON to 100% (all channels) if DMX512 signal is present. Returns to DMX level when button is released.

LED Modules - LED Indicators

The two LEDs associated with each channel report various operating conditions. The Red LED turns on for approximately 4 seconds on power-up, and after that the indications are as follows:

Red LED	Green LED	Condition
On	Off	No Communications with Head-End Processor
Off	On	Module is set to 100% by Focus button

LED Modules - Data / Power Connections

Below is a diagram on how to wire to the connectors in the LED Module 4-pin connectors.

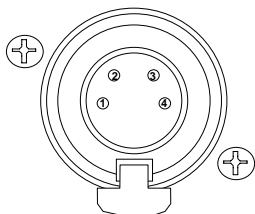

LED Module 4-Pin Connector Pinout:

Pin	Signal
1	+24 Volts DC
2	Not Used
3	Data
4	Ground

Only for use with:

Philips Color Kinetics	Philips Selecon
iW Blast	PLW-WW
TR Blast	PLW-RGB
TRX Blast	PLW-RGBAW

WARNING! This connector (on LED Modules) is for use with specified LED fixtures only. Use or connection of any other device will damage module and void the eS21 LED Raceway’s warranty.

LED Modules - LED Luminaire Connection, Setup, and Addressing

Connection and setup of a LED luminaire to a LED Module:

Step 1. Connect LED luminaire to LED module output connector.

Note: LED modules will be displayed on LCD Menu as Module Number and Port Number. If the LED luminaire is connected to Module 2, Port 3 it will be displayed on the LCD Menu as "2/3". See "[MOD/PORT STATUS \(LED Module status information shown, no user-selectable options\)](#)" on page 17.

Step 2. Set luminaire type in one of two ways:

- Using the LED Type menu option, Discover and the strip will determine the luminaire type as described in "[MOD/PORT CONFIG \(LED Module configuration, user-selectable options\)](#)" on page 19. **OR;**
- Using the LED Type menu options, WW, RGB, or RGBAW and set luminaire type directly as described in "[MOD/PORT CONFIG \(LED Module configuration, user-selectable options\)](#)" on page 19.

Step 3. As described in "[MOD/PORT DMX ADDR \(Sets DMX Address to Each Port, user-selectable options\)](#)" on page 19, using LCD Menu, set DMX Address for connected luminaire.

Note: DMX Address resides at the LED module's port, not the LED luminaire.

Relay Modules

Each eS21 LED Raceway Relay Module contains two independent relays. See **Figure 3** for more information.



Figure 3: Relay Module Focus Buttons / LED Indicators

Relay Module - Focus Buttons

The Focus Buttons can be used to quickly to operate or test the module as follows:

- The relay module focus button is either an ON or OFF button.
- Tapping the focus button will turn the circuit on, tapping it again will turn the circuit off.

Relay Modules - LED Indicators

The two LEDs associated with each relay report various operating conditions. The Red LED turns on for approximately 4 seconds on power-up, and after that the indications are as follows:

Red LED	Green LED	Condition
Off	Off	Normal
Off	On	Focus Mode (controlled at relay module)
On	Off	Communication Error
Flashing	Flashing	Miswire to Line

OPERATION AND PROGRAMMING

1. LCD Menu Operation

The Head-End Processor LCD Display Menu system consists of nine main categories. To navigate the menus, press the four navigation buttons as required (**Figure 4**). When the desired menu is reached, press the [Enter] button to display the menu options. Use the navigation and [Enter] buttons to view status and/or configure the parameters as required.

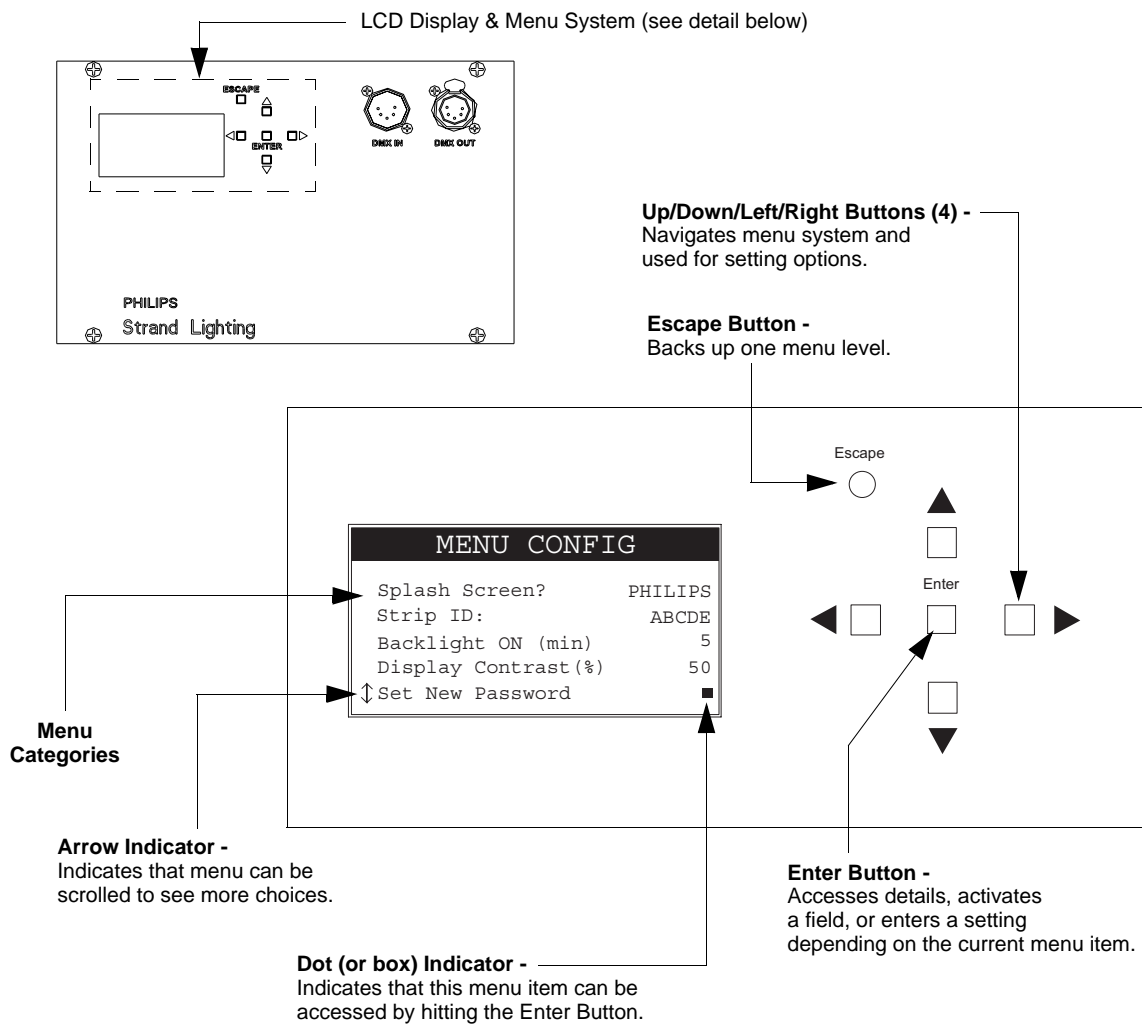

Figure 4: LCD Display and Menu System



2. Splash Screens

On Power-up the eS21 will display the Philips Logo Splash Screen for 5 seconds and then displays the User selectable Splash Screen. All four Splash Screens are accessible by multiple taps of the Escape button. The Main Menu select screen is accessible by tapping any of the navigation buttons.

Note: To return to the power up screen after boot up, press the [Escape] button.

Splash Screen Symbols

The following symbols are used in the Splash Screens:

Symbol	Name	Meaning
	Unlocked	The menu system is password-protected but is currently unlocked and will accept changes.
	Locked	The menu system is password-protected and locked and will not accept changes until the password is entered.
	DMX	This symbol appears if the eS21 LED strip is receiving a DMX512 signal.

Philips Splash Screen 1

Figure 5 is an illustration of Splash Screen 1:

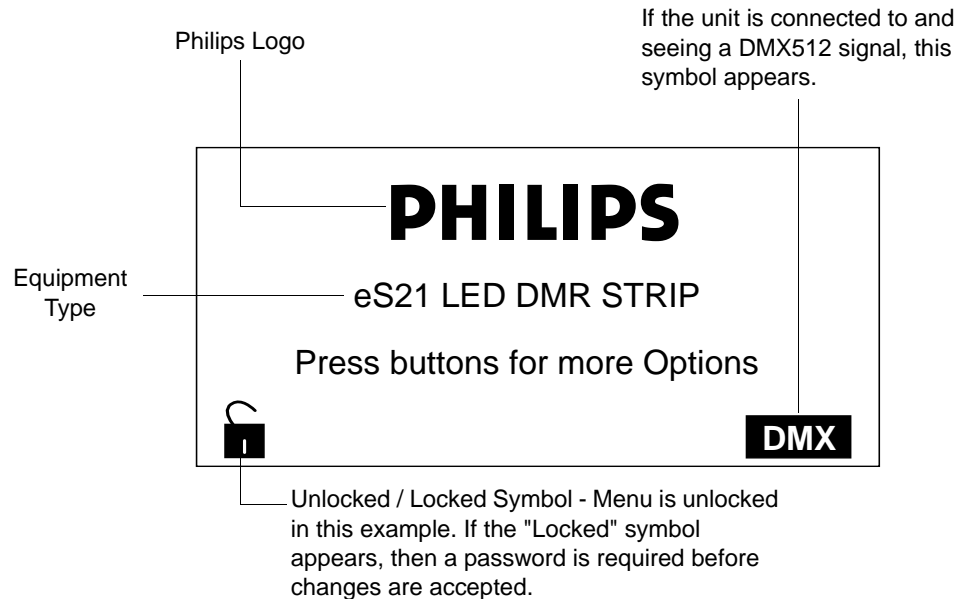

Figure 5: Splash Screen 1

eS21 LED Strip DMX Splash Screen 2

Figure 6 is an illustration of Splash Screen 2:

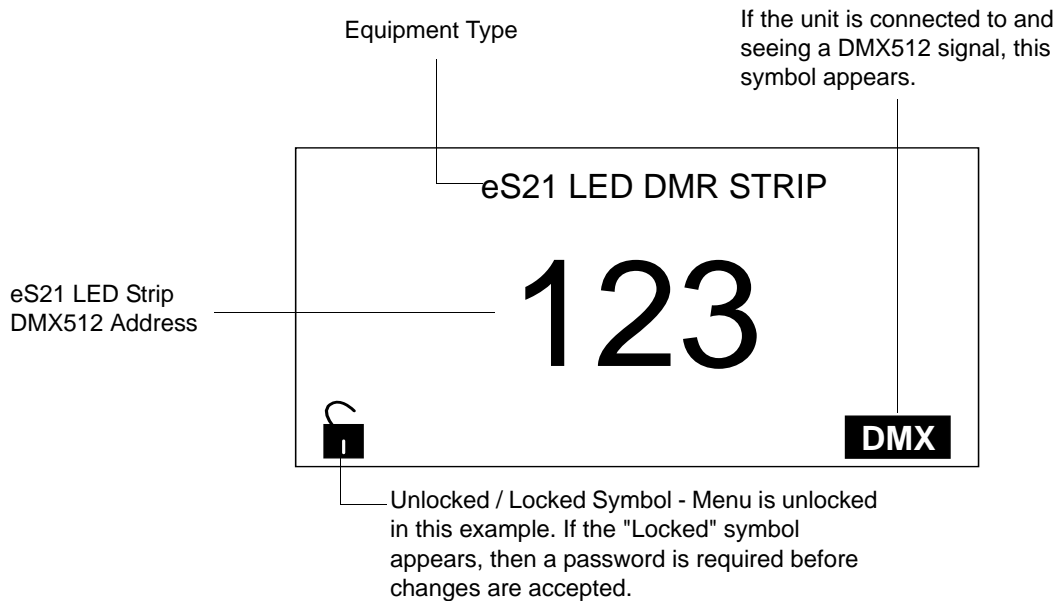

Figure 6: Splash Screen 2

User ID Splash Screen 3

Figure 7 is an illustration of Splash Screen 3:

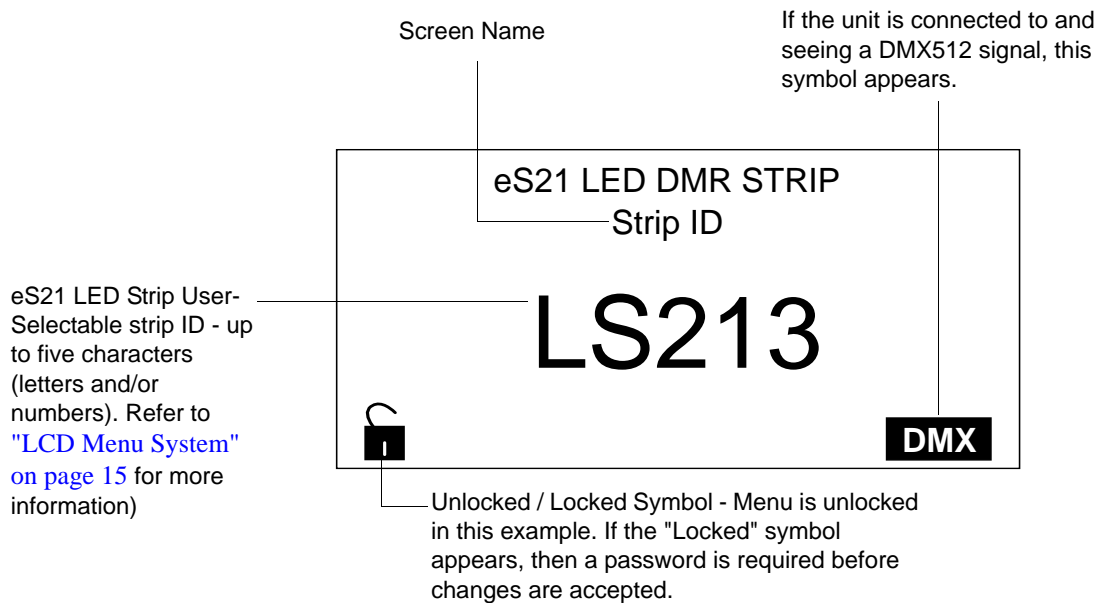

Figure 7: Splash Screen 3

Port DMX Splash Screen 4

Figure 8 is an illustration of Splash Screen 4:

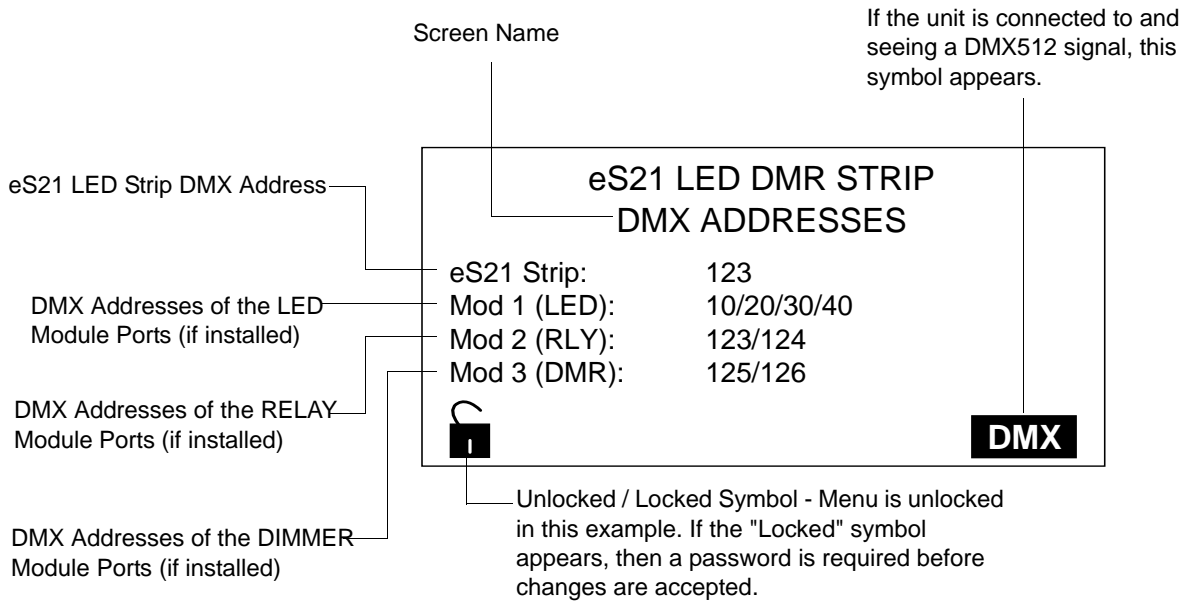
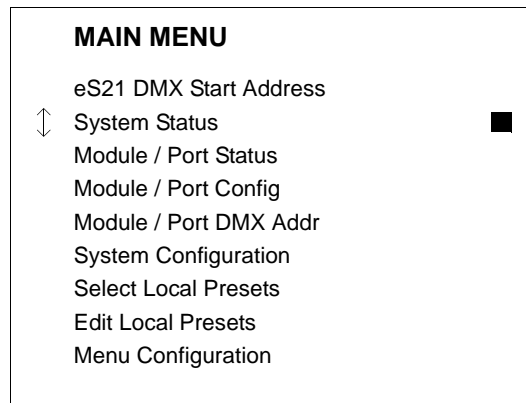

Figure 8: Splash Screen 4

3. LCD Menu System

The Head-End Processor LCD Display Menu system consists of several main categories. To navigate the menus, press the four navigation buttons as required (Figure 4). When the desired menu is reached, press [Enter] to display the menu options. Use navigation and [Enter] buttons to view status and configure the LCD Menu as required.

LCD Menu Structure



Continued next page

LCD Menu Structure (continued)

Continued from previous page

eS21 Start Addr (eS21 DMX Start Address)

Sub Menu	Options	Comments
eS21 DMX Start Addr	Sets DMX512 address (0 to 512)	Left and Right keys for -10 or +10 / Up and Down keys for +1 or -1 for addressing
Mod 1 (LD)	Not Applicable	Displays Module 1 (Type=LED) and Port DMX Addresses
Mod 2 (RL)	Not Applicable	Displays Module 2 (Type=RELAY) and Relay DMX Addresses
Mod 3 (DM)	Not Applicable	Displays Module 3 (Type=DIMMER) and Dimmer DMX Addresses

SYSTEM STATUS (status information shown, no user-selectable options)

Sub Menu	Options	Comments
Type	Not Applicable	Displays eS21 LED Dimmer Strip
Mod/Port Status	Not Applicable	Displays either OK (no errors) or Errors
Mod/Ports Available	Not Applicable	Displays the number of Modules and Ports available
Mod/Ports with Errors	Not Applicable	Displays Number of Modules and Ports with Errors
Firmware	Not Applicable	Displays head-End Processor current firmware version as, "86-XXXX vX.XX)

MOD/PORT STATUS (Dimmer Module status information shown, no user-selectable options)

Sub Menu	Options	Comments
Mod/Port	Not Applicable	Displays Module, Port and DMX Address
Level	Not Applicable	Displays dimmer's current operational level - Average or All Channels (in percentage)
TMP	Not Applicable	Displays current temperature of dimmer (displayed in both C and F)
Line	Not Applicable	Displays input line voltage in Volts AC
Load	Not Applicable	Displays connected load to dimmer in Watts
Status	Not Applicable	Displays Status of dimmer Normal , Non-Dim , or Breaker Off? (if no power to dimmer)
Errors	Not Applicable	Displays if the dimmer module is experiencing any errors
Mod	Not Applicable	Displays the module type and version number (PLW Ver ID)

Continued next page

LCD Menu Structure (continued)

Continued from previous page

MOD/PORT STATUS (Relay Module status information shown, no user-selectable options)

<i>Sub Menu</i>	<i>Options</i>	<i>Comments</i>
Mod/Port	<i>Not Applicable</i>	Displays Module, Port and DMX Address
Level	<i>Not Applicable</i>	Displays relay's current operational level (in percentage)
Status	<i>Not Applicable</i>	Displays Status of relay Non-Dim or Breaker Off? (if no power to relay)
Errors	<i>Not Applicable</i>	Displays if the relay module is experiencing any errors
Mod	<i>Not Applicable</i>	Displays the module type and version number

MOD/PORT STATUS (LED Module status information shown, no user-selectable options)

<i>Sub Menu</i>	<i>Options</i>	<i>Comments</i>
Mod/Port	<i>Not Applicable</i>	Displays Module, Port and DMX Address
Level	<i>Not Applicable</i>	Displays connected LED fixture's current operational level - an average of all color channels (in percentage)
Load	<i>Not Applicable</i>	Displays connected LED fixture's wattage
DMX Map	<i>Not Applicable</i>	Displays DMX Mapping applied to Port including Type (WW, RGB, RGBAW), and Resolution (8/16 bit)
LED Type	<i>Not Applicable</i>	Displays LED fixture's type: WW , RGB , or RGBAW
Errors	<i>Not Applicable</i>	Displays if the LED port is experiencing any errors
Mod	<i>Not Applicable</i>	Displays the module type and version number

Continued next page

LCD Menu Structure (continued)

Continued from previous page

MOD/PORT CONFIG (Dimmer Module configuration, user-selectable options)

Sub Menu	Options	Comments
Mod/Port	Not Applicable	Displays Module, Port and DMX Address
Mode	RPC (Reverse Phase Control)	Sets dimmer operation to reverse phase control
	FPC (Forward Phase Control)	Sets dimmer operation to forward phase control
	Non-Dim	Sets dimmer operation to non-dim operation (On or Off operation only - no dimming)
	LED - RPC (Reverse Phase Control)	Sets dimmer for line voltage LED fixtures that require locked reverse phase control dimming.
	LED - FPC (Forward Phase Control)	
Non Dim %	0 to 100%	When dimmer is set to Non-Dim, this option sets the dimmer's threshold level (selection 0 to 100%). Levels below the set percentage will turn the dimmer off and levels equal to or above the set percentage will turn the dimmer on. *WARNING: Setting a dimmer to act as a Non-Dim device is NOT recommended to control loads that require a solid-state relay. Doing so could damage the device and/or dimmer.
Voltage at Full (VAC)	200 / 220 / 230 / 240 VAC	Sets dimmer operational voltage. NOTE: Using a lower voltage than lamp specification can prolong lamp life.
Transition (uS)	400 / Auto	Options available (in both FPC and RPC) are either 400 (set) or AUTO (automatically and continuously adjusts between 400 or 1000 uS)
Dimmer Curve	Linear / Square Law / Invert / Slow Bottom / Fast Bottom / Fast Top / Full at 1 / Out at 100 / Preheat 5% / Preheat 10% / Hot Patch / Adv Mark 10 (fluorescent ballasts)	Sets dimmer curve (dimming operation) for each dimmer in the eS21 LED Strip
High Trim	1 to 100%	Sets the top end of the dimmer operational limit
Low Trim	0 to 99%	Sets the low end of the dimmer operational limit
Always On	Yes or No	If set to Yes, then the dimmer stays on to the Low Trim setting.
Preheat	Yes / No	Allows dimmer to be set to preheat mode. Normally preheat mode is used to "speed up" large wattage lamps so they behave more like smaller ones

MOD/PORT CONFIG (Relay Module configuration, user-selectable options)

Sub Menu	Options	Comments
Mod/Port	Not Applicable	Displays Module, Port and DMX Address
Non Dim %	0 to 100%	This option sets the relay's threshold level (selection 0 to 100%). Levels below the set percentage will turn the relay off and levels equal to or above the set percentage will turn the relay on.

Continued next page

LCD Menu Structure (continued)

Continued from previous page

MOD/PORT CONFIG (LED Module configuration, user-selectable options)

<i>Sub Menu</i>	<i>Options</i>	<i>Comments</i>
Mod/Port	<i>Not Applicable</i>	Displays Module, Port and DMX Address
LED Type	<i>WW (White / White)</i>	Sets the LED module as White / White luminaire
	<i>RGB (Red, Green, and Blue)</i>	Sets the LED module as RGB luminaire
	<i>RGBAW (Red, Green, Blue, Amber, White)</i>	Sets the LED module as RGBAW luminaire
	<i>Discover</i>	The LED Module will automatically detect the type of connected LED fixture.
DMX Ctrl (DMX Control)	<i>Normal</i>	Maps only the color channels
	<i>Intensity +</i>	Adds an Intensity channel to the color channels
	<i>PL Mode +</i>	Adds full PL Mode to color channels (Intensity, Colors, Preset Colors, Fade Rate, Strobe, and Control)
Color Resolution	<i>8 Bit / 16 Bit (note, white is 8 bit only)</i>	Sets the resolution of the color channels (one or two DMX slots).
DMX Map	<i>Not Applicable</i>	Displays resulting DMX Mapping for Port
Edit	<i>Copy, Paste, 1</i>	Copies present Port Config and allows Pasting to other selected ports
	<i>Copy, Paste All</i>	Copies present Port Config and allows Pasting to all ports

MOD/PORT DMX ADDR (Sets DMX Address to Each Port, user-selectable options)

<i>Sub Menu</i>	<i>Options</i>	<i>Comments</i>
Mod/Port	<i>Not Applicable</i>	Displays Module, Port and DMX Address
Strip DMX Addr	<i>Not Applicable</i>	Displays the eS21 LED Strip's Starting DMX512 Address
Port Address Type	<i>Manual</i>	Sets DMX Address Manually (not linked to Strip)
	<i>Strip</i>	Sets DMX Address linked to Strip Starting Address
Port DMX Address	<i>XXX (1 to 512)</i>	Sets DMX Address of Port
	<i>XXX ([Strip Address] to 512)</i>	Minimum address is 1 for Manual Addressing / Minimum address is 'Strip Address' for Strip Addressing

Continued next page

LCD Menu Structure (continued)

Continued from previous page

SYSTEM CONFIG (Sets System Options, user-selectable options)

Sub Menu	Options	Comments
DMX Hold (hh:mm) (in hours : minutes)	None / 0:01 / 0:05 / 0:10 / 0:15 / 1:00 / 2:00 / 4:00 / 12:00 / 24:00	Sets the amount of time the eS21 LED Strip will keep and adhere to the last DMX512 levels
Power-up Preset	None / 1 / 2 / 3 / 4 / 5 / 6 / 7 / 8	Sets what preset the output device go to when LED strip is initially powered
Power-up Hold	Forever / 0:01 / 0:05 / 0:10 / 0:15 / 1:00 / 2:00 / 4:00 / 12:00 / 24:00	Sets the amount of time the output devices will go and stay at the preset level (if set) when the LED strip is initially powered.

SELECT PRESET (Selects Recorded Strip Presets)

Sub Menu	Options	Comments
Preset	1 / 2 / 3 / 4 / 5 / 6 / 7 / 8	Selects the recorded preset

EDIT PRESETS

Sub Menu	Options	Comments
Mod/Port	Not Applicable	Displays Module, Port and DMX Address
Preset	1 / 2 / 3 / 4 / 5 / 6 / 7 / 8	Selects the preset to be programmed
Level (%)	0 to 100% (in 1% increments)	Selects the preset level of the dimmers, relays or PL Wash (each dimmer is individually programmable)
Dimmer Set	One / All / Capture All	Allows users to set preset to one or all dimmers or luminaires (at the same time) or Capture (snapshot) a look from DMX

MENU CONFIG

Sub Menu	Options	Comments
Set Splash Display	Philips	Sets the display to Splash Screen 1 after a power up or time out
	Strip DMX	Sets the display to Splash Screen 2 after a power up or time out
	Strip ID	Sets the display to Splash Screen 3 after a power up or time out
	DMX ADDR	Sets the display to Splash Screen 4 after a power up or time out
Strip ID	# # # # #	Sets User ID. Each "#" can be set from A to Z, 0 to 9, dash ("-") or underscore ("_") to establish a five-digit strip ID.
Backlight On (min) (in minutes)	Always (always on) / 0 to 60 minutes (in 1 minute increments)	Sets the amount of time the Head-End Processor LCD Display backlight is on after last button press
Display Contrast	0 to 100% (in 1% increments)	Allows user to set the contrast level of the LCD Display
Set New Password	# # # #	Each "#" can be set from 0 to 9 (numeric only) to establish a four-digit password. For more information, see "LCD Display Passwords and Security" below.

LCD Display Passwords and Security

Setting a password and locking the LCD menus prevents unwanted changes to system or dimmer operational settings. Status information (of the LED Raceway system and individual dimmers) can still be viewed through the menu status screens.

eS21 LED Raceways are shipped without an established password. Users must set their own password (four-digit number) before the LCD menu options can be locked. When setting a password, write it down and keep it in a secure location. Note, Strand Lighting does not have records of passwords established by users or owners.

Setting or Changing a Password

- Step 1. From LCD Display MAIN MENU, scroll to MENU CONFIGURATION (MENU CONFIG) screen.
- Step 2. At MENU CONFIG, select "Set New Password"
- Step 3. Using Up [▲] / Down [▼] / Left [◀] / Right [▶] arrow buttons, set each "#" to establish a four-digit password.
- Step 4. When each "#" sign has been assigned a number, hit [Enter] (center button on display). If you hit [ESC] (Escape) password will not be stored and process must be repeated.
- Step 5. Password is set. After 15 minutes of inactivity (no menu button presses), the LCD menu will go into locked mode (changes cannot be made to menu options unless the password is entered).
- Step 6. To force the LCD Display into lock mode, please see ["Lock System Now \(forcing the LCD menus into lock mode\)"](#).

Lock System Now (forcing the LCD menus into lock mode)

Note: Before the LCD menus can be locked, a password must be established by user. If a password has not been set, see ["Setting or Changing a Password"](#).

- Step 1. From LCD Display MAIN MENU, scroll to MENU CONFIGURATION (MENU CONFIG) screen.
- Step 2. At MENU CONFIG, select "Lock System Now" and hit [Enter] on menu.
- Step 3. System is locked. A lock symbol will be displayed on the main screen to show LCD Display is locked (note, changes cannot be made to menu settings unless the password is entered. System and dimmer status can be viewed in locked mode).

4. IGBT Dimmer Load Types

General

eS21 dimmers are designed to operate a wide variety of lighting loads of up to their rated capacity. The range of load types which may be connected includes incandescent lamps, and a number of "well-behaved" inductive loads such as low-voltage (step-down transformer) fixtures, fluorescent lamps, and most types of small motors used in special effects equipment such as wind or fog machines.

WARNING! eS21 dimmers are not designed to drive large motor loads (3 Amps or greater), or motors with start-up capacitors. Attempting to drive such loads may damage the dimming electronics or dimmer.

Low-Voltage Fixtures

When operating low-voltage type fixtures, observe the following precautions: If the fixture has a conventional magnetic transformer, be sure it has internal fusing and is approved for dimming by its manufacturer. Load the dimmer to only 80% of its capacity (i.e., 960VA for a 1.2KW dimmer) to compensate for losses in the transformer. If the fixture has an "electronic transformer", make sure it is approved for dimming by its manufacturer.

Neon Fixtures

Neon fixtures and signs can be particularly difficult to dim as they tend to reflect back nearly all of the energy which is applied to them. For best results with neon, a dimmer should be loaded to no more than 50% of its capacity (i.e., 600VA for a 1.2KW dimmer), should be configured for Forward Phase Control operation, and should have an

incandescent load of 100 to 200 watts added to help absorb the reflected energy. Failure to take these precautions may result in damage to the dimming electronics or dimmer.

Also, for best results, increase the neon transformer voltage 50% over the normal requirements for the selected length and diameter of the tube. Use only Low Power Factor (without power factor compensation), current limiting, high-voltage transformers. Mount the transformer with the lamp it operates. This will increase lamp stability and dimming range. Neon tubes must be pumped for a hard vacuum to minimize impurities in the lamp to insure flicker-free operation at low light levels.

LED Line-Voltage Fixtures

eS21 LED Raceways offer a dedicated dimming option for line-voltage LED fixtures. LED fixtures that require a locked reverse-phase control dimming curve is available through the LCD menu system. Refer to "["MOD/PORT CONFIG \(Dimmer Module configuration, user-selectable options\)"](#) on page 18 on how to set a dimmer to the LED dimming mode.

Non-Dim Operation

When set for Non-dim operation, the eS21 dimmers bypass the dimming modes mentioned above, and simply switches into full conduction. Normal overload protection is still active, but the dimmer does not attempt to regulate its output voltage. Non-dim mode is intended to control small motors and fans such as those found in color scrollers and scenic projectors.

WARNING! eS21 dimmers, in non-dim mode, are not designed to run automated luminaires, large loads, or flash pots. Damage to the dimmer or attached equipment may occur.

5. Dimmer Protection

eS21 dimmer can detect an overload in several ways:

- 1) By calculating the load size from the measured voltage and current. This protects the dimmer from mis-sized loads, such as connecting more than its rated wattage to a single dual dimmer module.
- 2) By the hardware current limiter shutting down the dimmers output. This protects the dimmer from catastrophic faults like short circuits.

The Over-sized load threshold is about 35% above the nominal dimmer capacity. This gives enough latitude for lamp manufacturing tolerances and load shift with temperature, yet still protects the dimmer from gross loading errors.

Once an overload has been detected, the dimmer spends about 5 seconds monitoring the load before deciding to shut down. If the hardware current limit caused the fault, the load is monitored at extremely low voltages. If the fault has not cleared at the end of this time, the dimmer shuts down and reports the error. Depending on the cause, the Status Monitor will show either "Over-sized Load", or "Overload".

The load must be reduced to the correct size and the level must be reset to zero before the dimmer will resume normal operation.

Thermal Protection

The portion of the eS21 dimmer output wave form which generates the most heat is the transition from on to off (off to on for FPC). This portion is known as the transition time, and its duration directly affects the amount of heat generated. The eS21 dimmer can control the duration of this portion of its output wave form and thus, to a certain degree, its operating temperature.

If the dimmer is in its normal operating temperature range, it will use the longest transition time available is 1000 μ S . Should its operating temperature reach 85° C (likely only if the ambient temperature is very high), it will automatically select a shorter transition time to reduce the amount of heat generated. In many cases this will be sufficient to stabilize the temperature. Should the temperature continue to rise, and reach 95° C, the dimmer will completely shut down to prevent an over temperature failure. After an over temperature shut-down the temperature must drop to 50° C and the level must be reset to zero to resume normal operation.

6. Replacing a Module



WARNING! Failure to disconnect power before servicing may result in injury.

To replace a module:

Step 1. Turn off or disconnect all power to eS21 LED Raceway.

Step 2. At module, loosen four screws and partially remove from system (**Figure 9**).

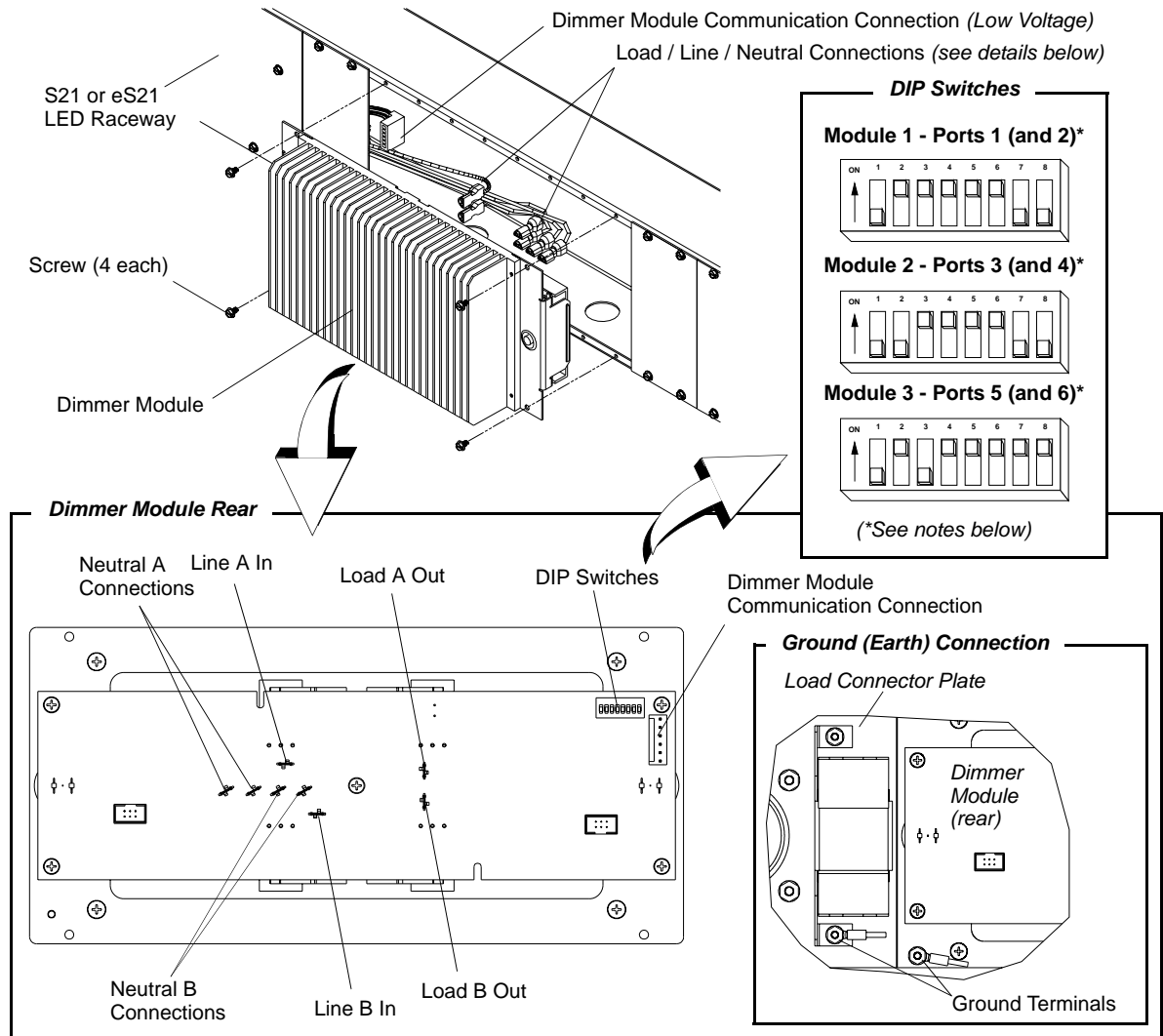

***NOTES:**

(1) Each module can support either 2 ports of dimming or relays OR 4 ports of LED.

(2) Addressing is set assuming 4 ports. Therefore, eS21 LED Raceways supports 1 - 3 - 5 addresses.

Figure 9: Removing and Replacing a Dimmer Module

- Step 3. Disconnect all wiring and completely remove module.
- Step 4. At new module, set DIP switches to same address as previous module or use module position 1 - 3 - 5 (as indicated in **Figure 9**).

WARNING! The address must exactly match the address of the dimmer being replaced. Failure to re-address the new dimmer will result in improper operation.

- Step 5. Connect all wiring (dimmer module communications, Neutral A, Neutral B, Line A In, Line B In, Load A Out, and Load B Out connections) to new module.
- Step 6. Insert new module into eS21 LED Raceway and replace four mounting screws.
- Step 7. Power up and test operation.

TECHNICAL SPECIFICATIONS

1. eS21 LED Raceway (230V/240V Model 71900)

Number of Modules:	3 Modules - as per customer order
Output Voltage:	200V / 220V / 230V / 240V (user selectable)
Minimum Load:	1 watt
Maximum Load/Dimmer:	2.5kW per Dual Dimmer Module or 5.0kW per Single Dimmer (max.)
Dimming Phase:	Forward or Reverse (user selectable or automatic)
Transition (Rise) Time:	Up to 650 μ S (automatic adjustable)
Insert Loss:	Max 2.5 volts
Power Feed:	3-phase 4 wire 240 / 420 volts ("WYE" power service) 25 amps; Terminal block.
Frequency:	50/60Hz
Ambient Temperature:	0 to 40 degrees C
Humidity:	5%-95% Non condensing
Cooling:	Natural Convection
Height:	152.4 mm
Depth:	101.6 mm
Length:	2,286.0 mm
Weight:	Depends on configuration
Load Connector Types:	Powercon or CEE17
Compliance:	CE Marked

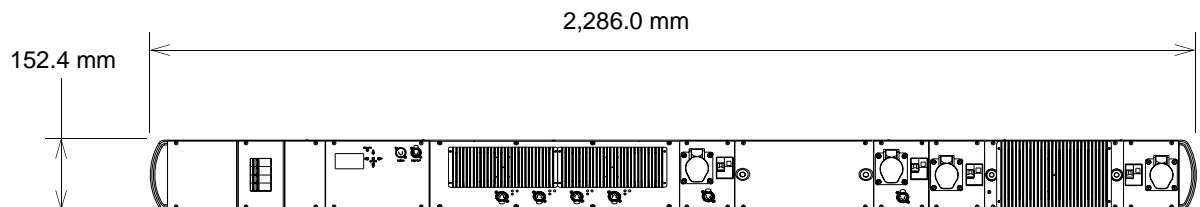

Notes:

1. Modules are per customer order. Modules shown are for illustrative purposes only.
2. Power Input Strain Relief (not shown) can be in one of three positions - top, bottom, or rear of unit at Field Wiring Compartment.

ACCESSORIES

Contact your Authorized Strand Lighting Dealer for price and availability of all accessories for eS21 LED Raceways. Additional information can be found on the Strand Lighting web site at www.strandlighting.com.

1. eS21 LED Raceway (230V/240V Model 71900)

Clamps / Mounting / Hangers / DMX512 Termination

Part Number	Description
71729	Hook Clamp
71351	Cheeseboro Clamp
71726	Pipe Mount Bracket (for use with Cheeseboro or Pipe Clamps)
71728	Wall Mount Bracket (metric)
71732	Single Pipe Mount Hanging Bracket
71733	Double Pipe Mount Hanging Bracket
71511	Dual Clamp Hanging Bracket
71346	DMX512 Terminator

Spare Modules

Part Number	Description
71701	Spare Processor / LCD Display Unit

Notes

